

CALIPER

- **METROLOGY**® Special Jaws Calipers, unique and modern design, solid structure made of hardened stainless steel hardness HRC 48-52, measuring anvils and jaws are precision grinded and polished.
- This series of calipers are design to suit special requirements/ manufacturing accuracy is based on ISO standards, in compliance to JCC.

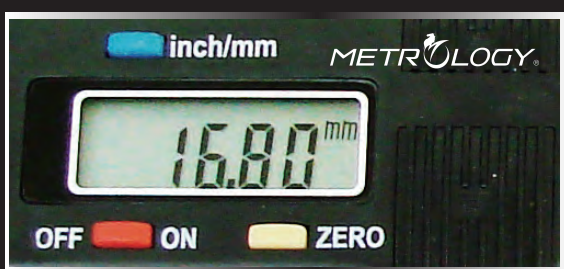

- Resolution: 0.01mm/ 0.0005"
- MM/INCH conversion button
- Manual ON/OFF button
- ZERO: Reset button
- 1.5V, LR 44 lithium battery

SPECIAL MEASURING JAWS

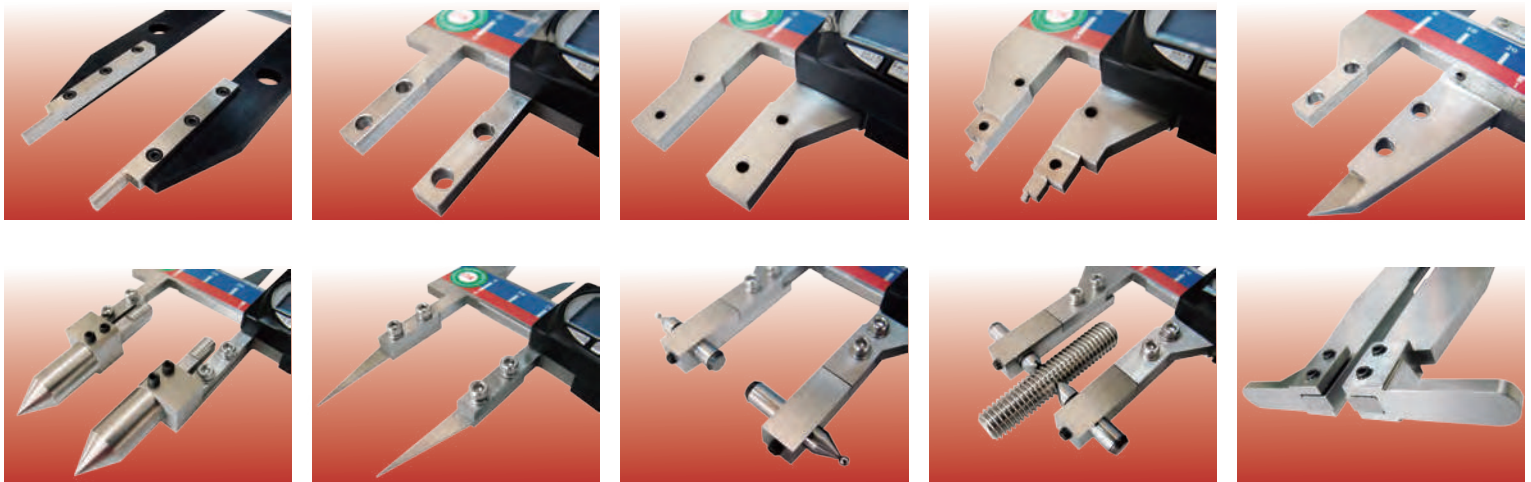
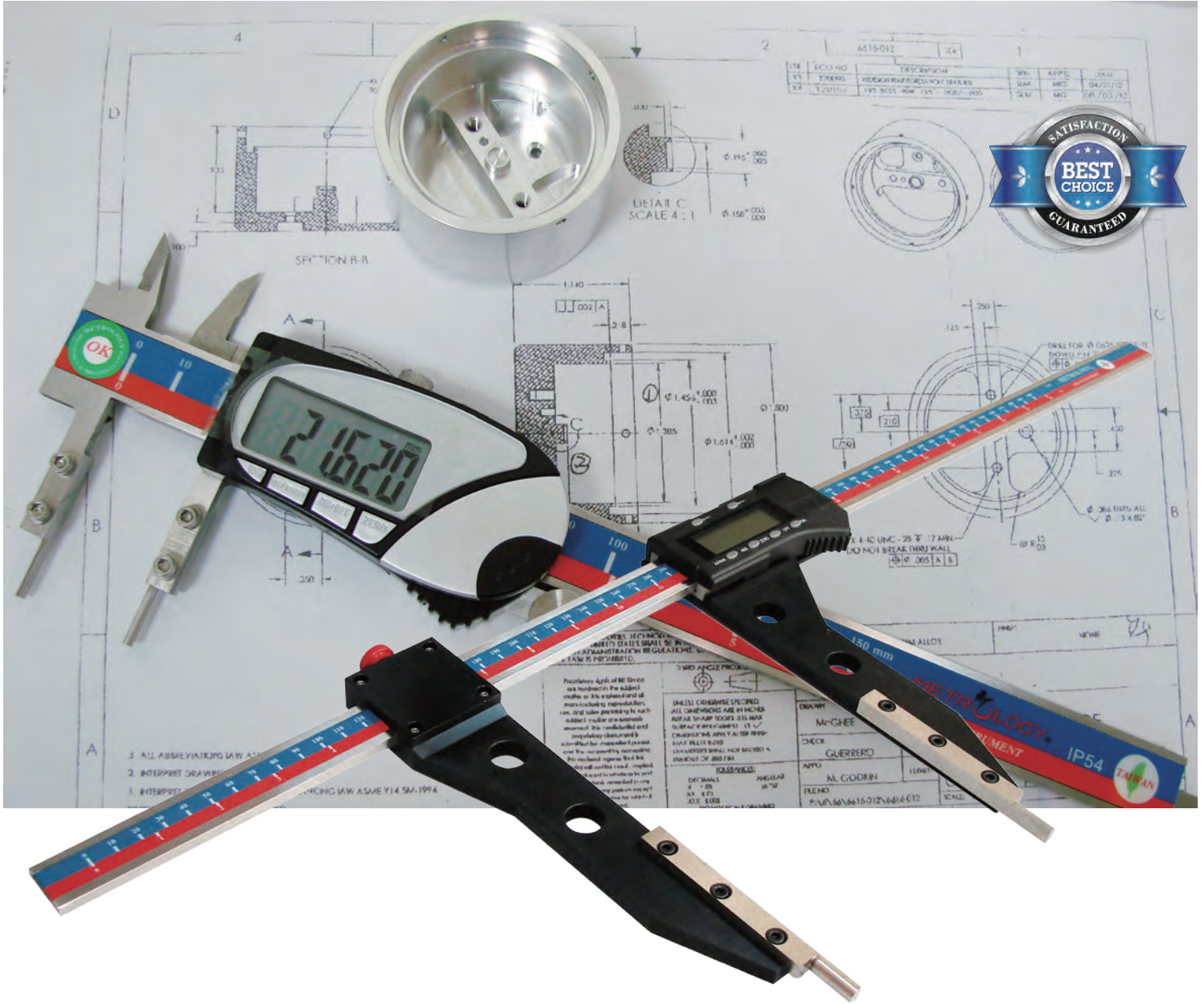

*The measuring jaw can be customized according to design drawing or measurement item of workpiece to suit your particular requirements.

■ Digital Caliper (Tungsten Steel)

For measuring high density materials, measuring the external, internal, depth, and step of work pieces. Tungsten steel on both internal and external jaws, ensuring durability.

Tungsten carbide is much more wear-resistant and durable than hardened stainless steel.

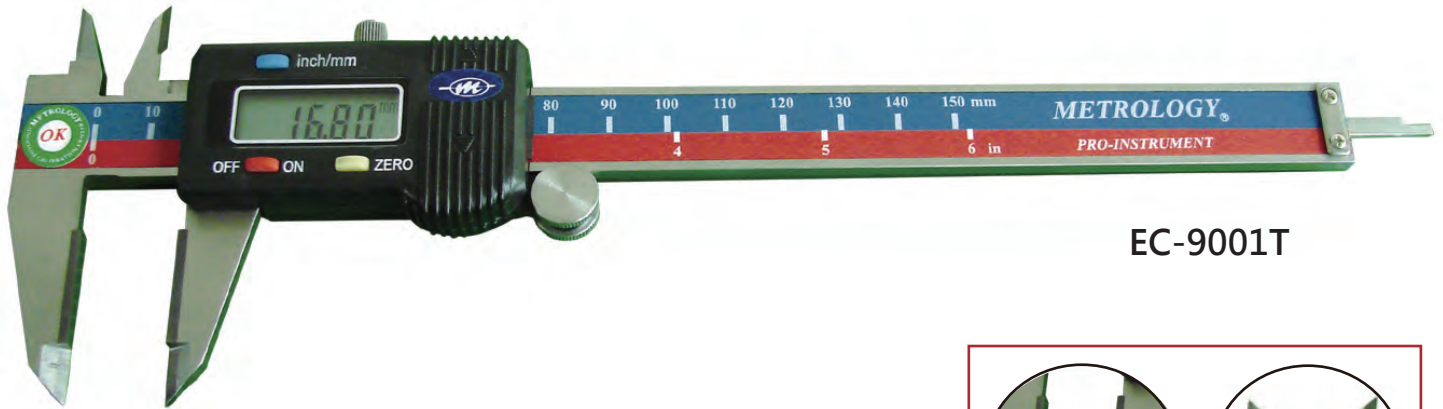

EC-9001T

Model No.	Measuring Range	Resolution	Accuracy
EC-9001T	0-150mm/6"	0.01mm/0.0005"	±0.03mm
EC-9002T	0-200mm/8"		±0.03mm
EC-9003T	0-300mm/12"		±0.04mm

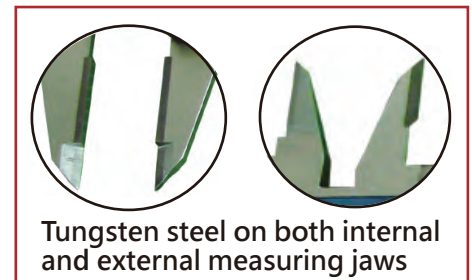

■ Digital Caliper (Depth)

For depth, thickness, height, and step measurements

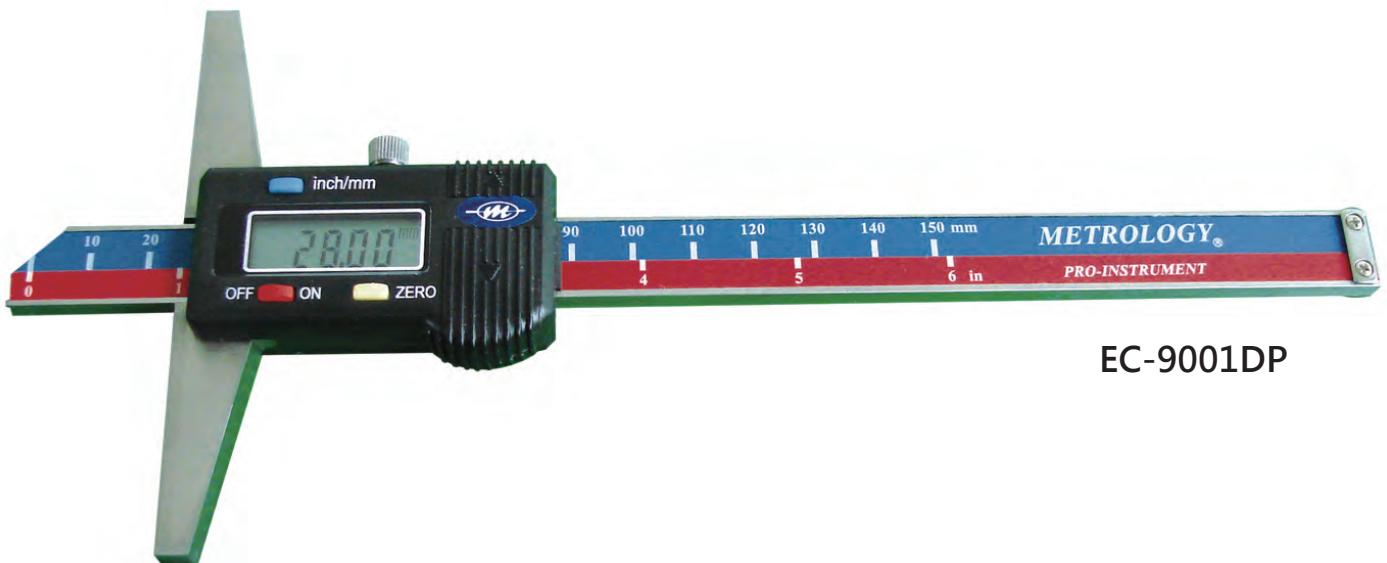

EC-9001DP

Model No.	Measuring Range	Resolution	Base Length	Accuracy
EC-9001DP	0-150mm/6"	0.01mm/0.0005"	100mm	±0.03mm
EC-9002DP	0-200mm/8"		100mm	±0.03mm
EC-9003DP	0-300mm/12"		150mm	±0.04mm
EC-9004DP	0-500mm/20"		200mm	±0.05mm
EC-9005DP	0-800mm/30"		200mm	±0.06mm
EC-9006DP	0-1000mm/40"		250mm	±0.08mm

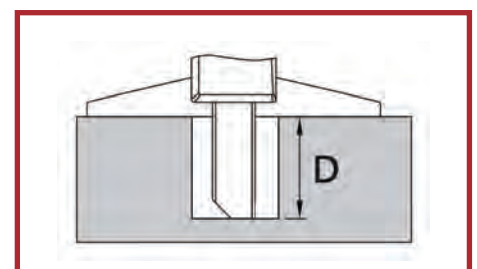

■ Digital Caliper (Outside Groove)

For measuring outside groove diameter, length, wall thickness of slots.

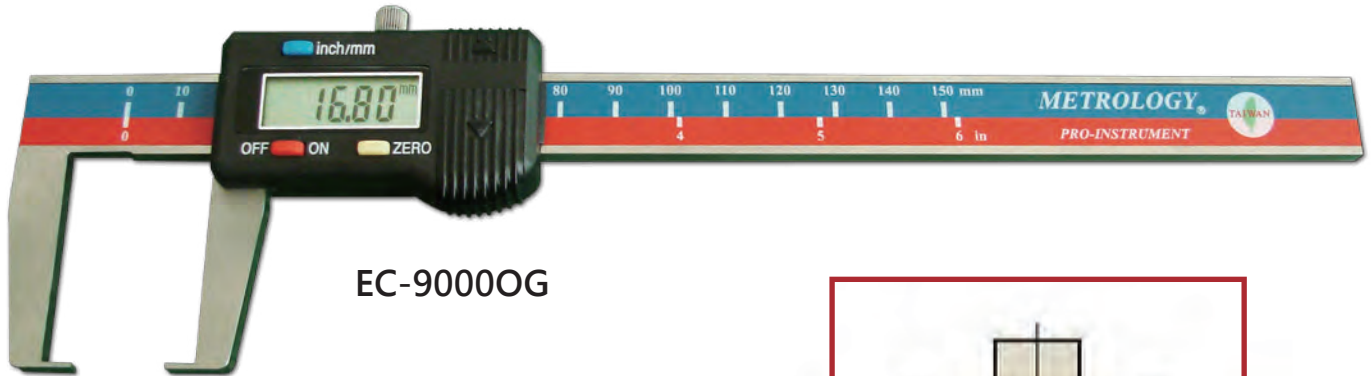

EC-9000OG

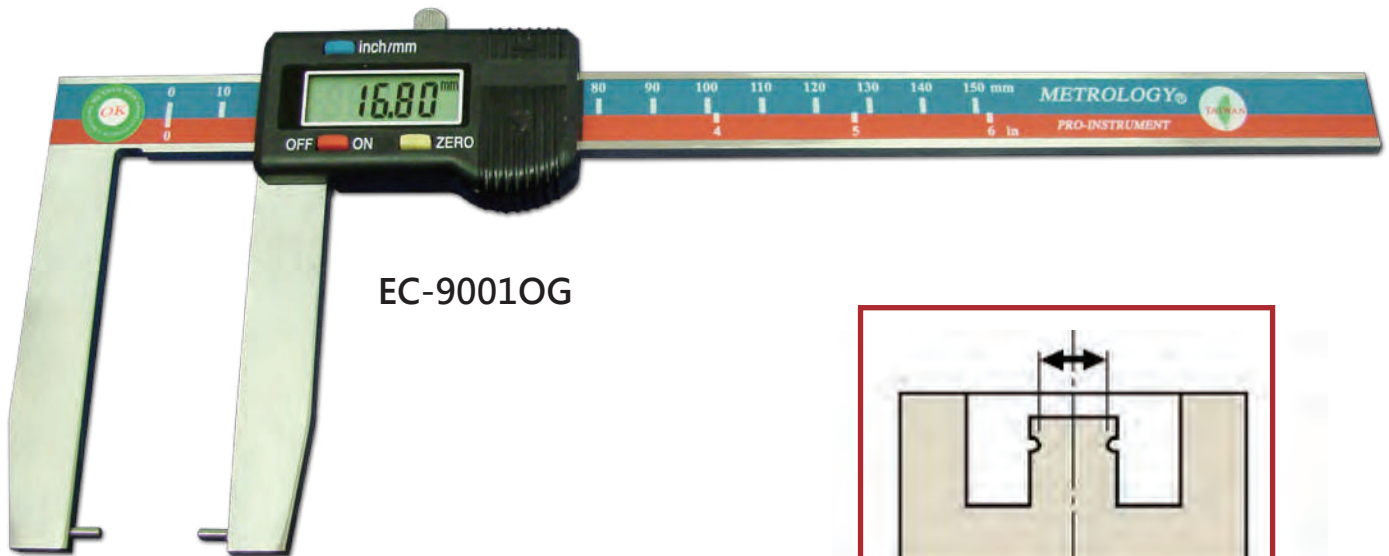
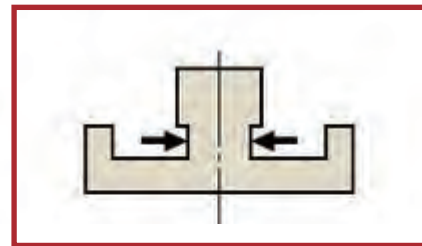

EC-9001OG

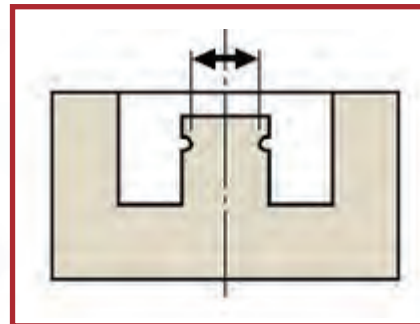

Model No.	Measuring Range	Resolution	Jaw Length	Anvil Dia	Anvil Length	Accuracy
EC-9000OG	0-150mm/6"	0.01mm/0.0005"	40mm	T1mm	5mm	±0.04mm
EC-9001OG	0-150mm/6"		70mm	∅3mm	7mm	±0.05mm
EC-9002OG	0-200mm/8"		110mm	∅3mm	12mm	±0.05mm
EC-9003OG	0-300mm/12"		150mm	∅3mm	12mm	±0.06mm
EC-9004OG	0-500mm/20"		200mm	∅3mm	12mm	±0.07mm

Remark: EC-9000OG come with flat measuring anvils, all other models come with curved anvils.

■ Digital Caliper (Inside Groove)

For measuring inside groove diameter, hole diameter, and distance of workpiece.

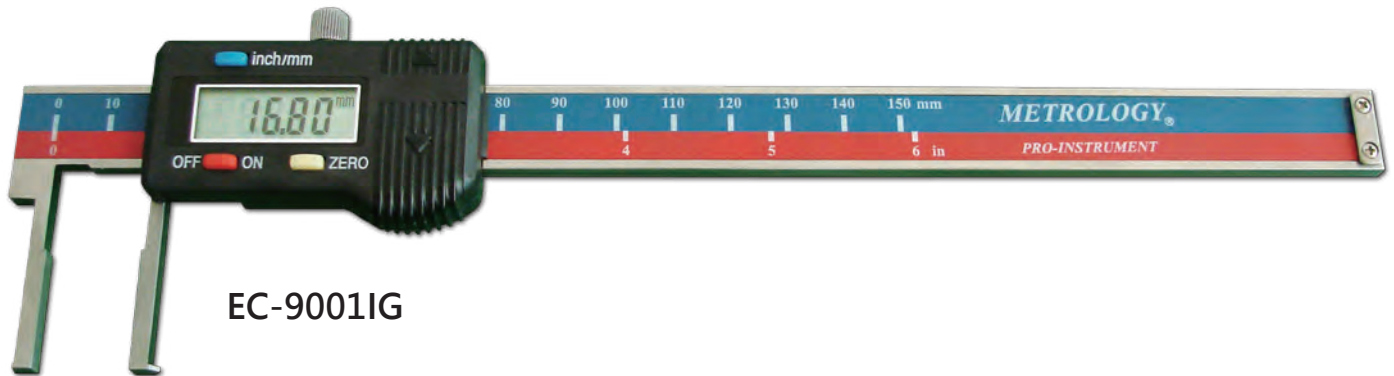

EC-9001IG

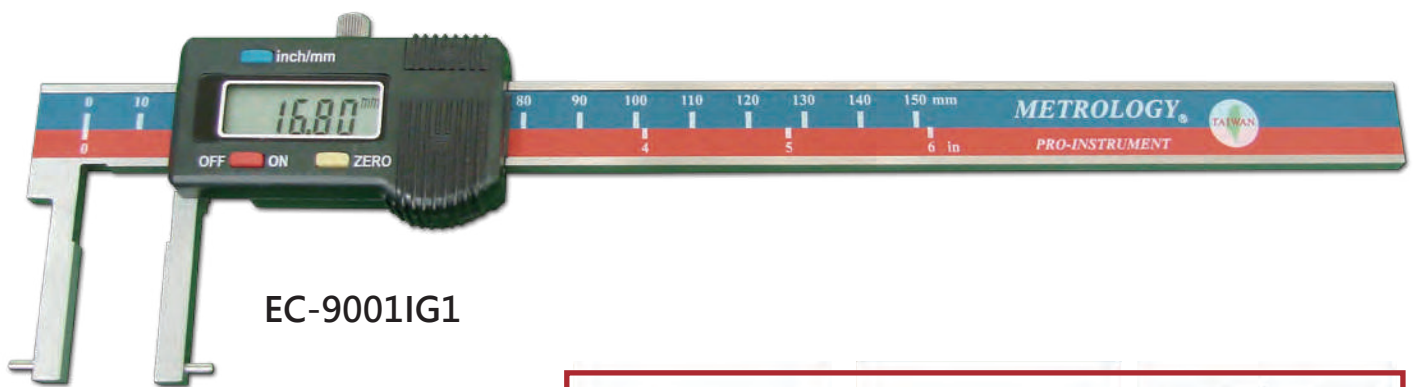

EC-9001IG1

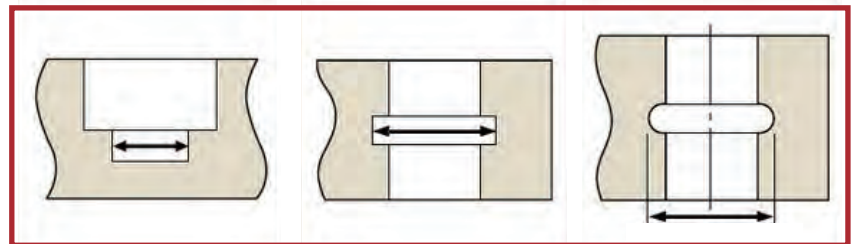

Model No.	Measuring Range	Resolution	Jaw Length	Anvil Dia	Anvil Length	Accuracy
EC-9001IG	10-150mm/6"	0.01mm/0.0005"	30mm	T1mm	2mm	±0.05mm
EC-9001IG1	20-150mm/6"		30mm	ψ2mm	5mm	
EC-9001IG2	35-150mm/6"		60mm	ψ2mm	6mm	
EC-9001IG3	50-150mm/6"		90mm	ψ3mm	8mm	±0.06mm
EC-9002IG1	25-200mm/8"		40mm	ψ2mm	5mm	±0.05mm
EC-9002IG2	40-200mm/8"		70mm	ψ3mm	7mm	
EC-9002IG3	60-200mm/8"		100mm	ψ3mm	10mm	
EC-9003IG1	30-300mm/12"		50mm	ψ2mm	5mm	±0.07mm
EC-9003IG2	50-300mm/12"		80mm	ψ3mm	10mm	
EC-9003IG3	60-300mm/12"		110mm	ψ3mm	10mm	
EC-9004IG1	40-500mm/20"		90mm	ψ3mm	5mm	±0.08mm
EC-9004IG2	60-500mm/20"		120mm	ψ3mm	10mm	
EC-9004IG3	80-500mm/20"		150mm	ψ3mm	16mm	

Remark: EC-9001IG come with flat measuring anvil, all other models come with curved anvils.

■ Digital Caliper (Inside & Outside Interchangeable Anvil)

For measuring outside groove diameter, length, wall thickness of slots, inside groove diameter, hole diameter, and distance of workpiece

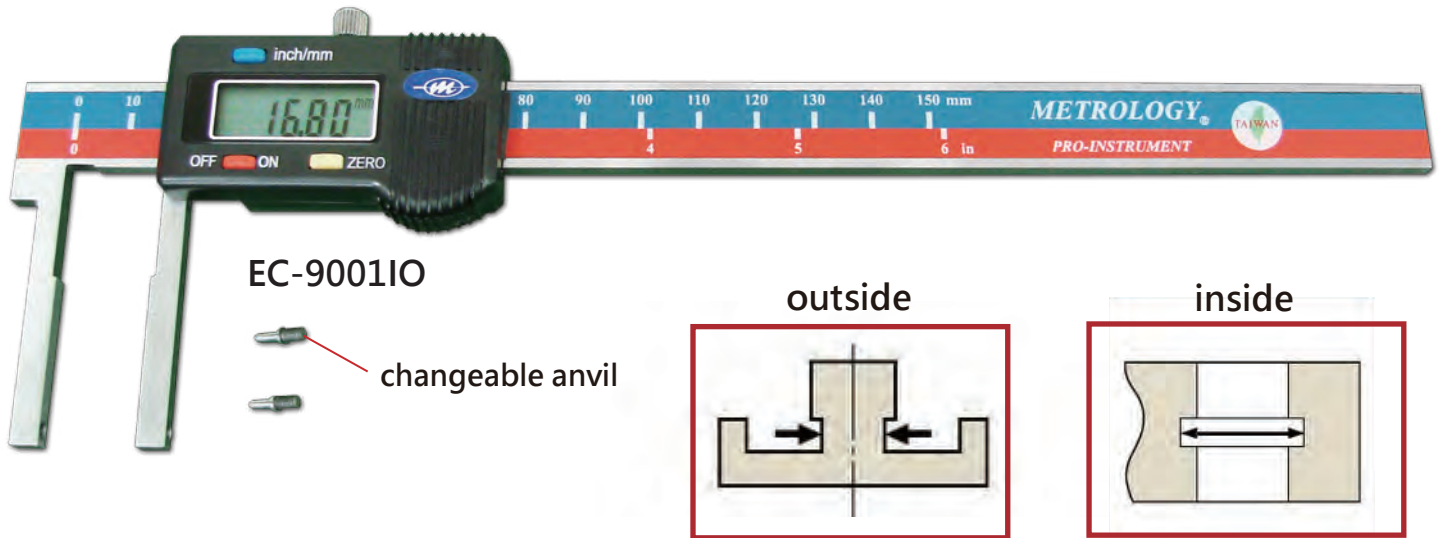

Model No.	Measuring Range	Resolution	Jaw Length	Anvil Dia	Anvil Length	Accuracy
EC-9001IO	0-150mm/6"	0.01mm/0.0005"	40mm	Φ2mm	5mm	±0.05mm
EC-9002IO	0-200mm/8"		50mm			±0.05mm
EC-9003IO	0-300mm/12"		60mm			±0.07mm
EC-9004IO	0-500mm/20"		100mm			±0.08mm

Remark: above measuring range is for external specs. For internal measurements, measuring jaw and anvil dimension must be added.

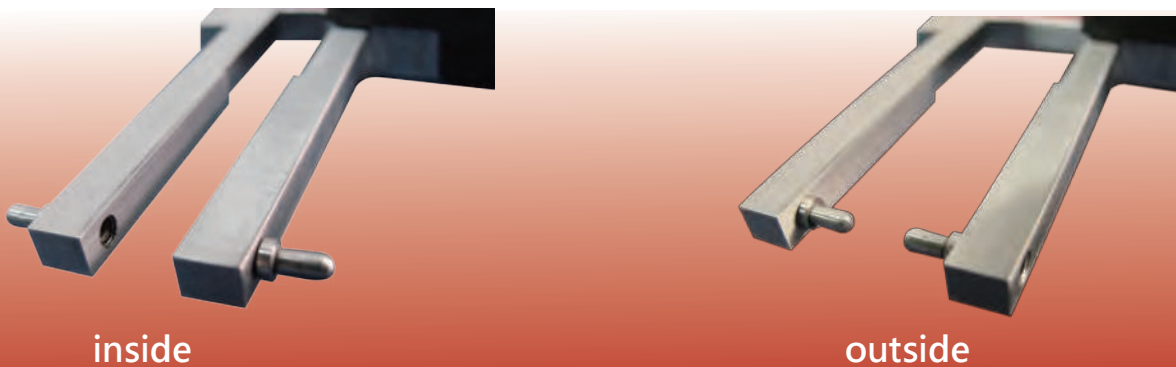

Remark: Measuring tip standard spec is M2.5-6g.

The interchangeable anvils with curved style and custom measuring anvils can be ordered.

■ Digital Caliper (Offset)

The main scale measuring jaw is adjustable.
For measuring outside and inside step distances.

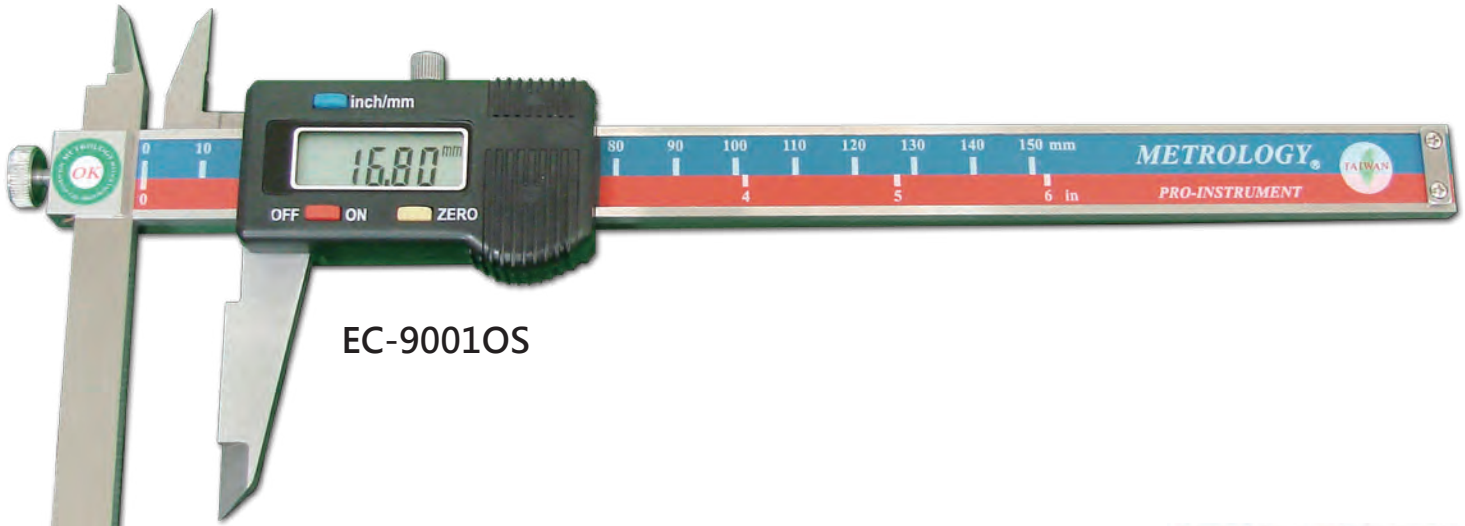

EC-9001OS

Model No.	Measuring Range	Resolution	Accuracy
EC-9001OS	0-150mm/6"	0.01mm/0.0005"	±0.04mm
EC-9002OS	0-200mm/8"		±0.04mm
EC-9003OS	0-300mm/12"		±0.05mm
EC-9004OS	0-500mm/20"		±0.06mm

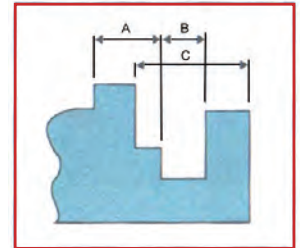

■ Digital Caliper (Tube)

For measuring thickness of the tube wall, and distance of datum point to hole.

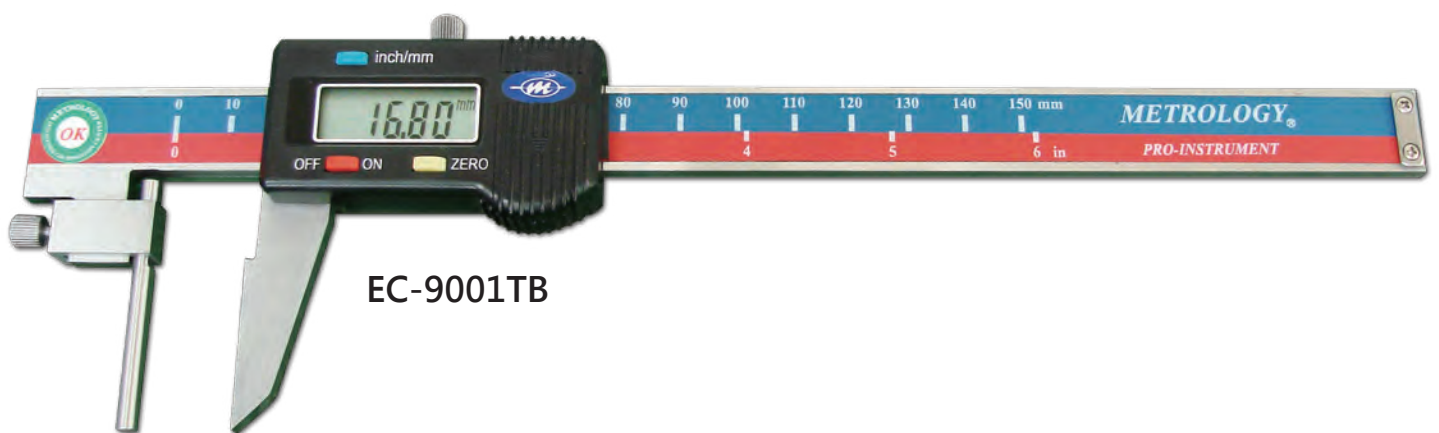

EC-9001TB

Model No.	Measuring Range	Resolution	Accuracy
EC-9001TB	0-150mm/6"	0.01mm/0.0005"	±0.04mm
EC-9002TB	0-200mm/8"		±0.04mm
EC-9003TB	0-300mm/12"		±0.05mm



Remark: Measuring rod standard diameter is 4mm, Custom spec and style can be special ordered.

■ Digital Caliper (Point)

For measuring tight spaces in slots.

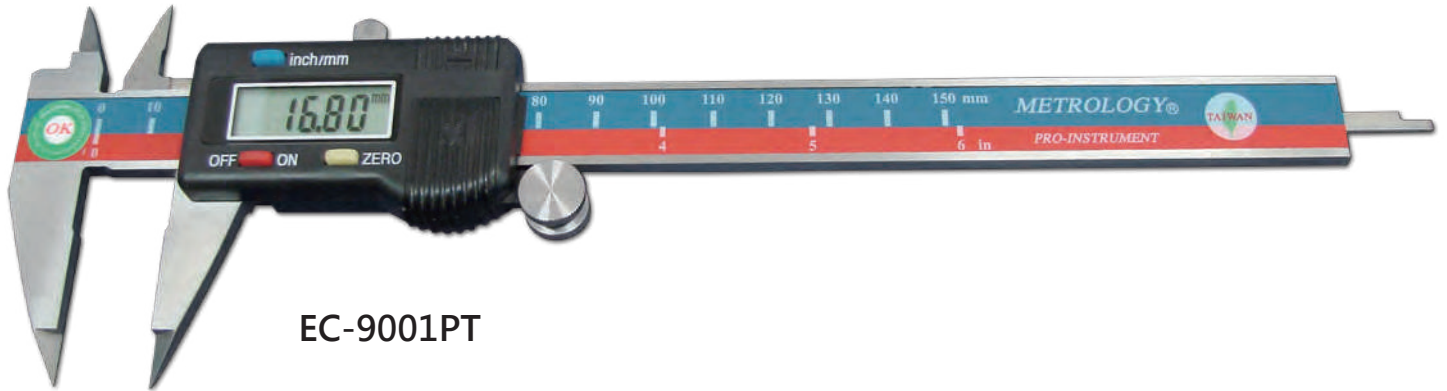

EC-9001PT

Model No.	Measuring Range	Resolution	Accuracy
EC-9001PT	0-150mm/6"	0.01mm/0.0005"	±0.04mm
EC-9002PT	0-200mm/8"		±0.04mm
EC-9003PT	0-300mm/12"		±0.05mm

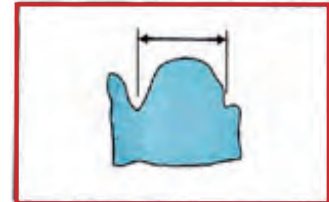

■ Digital Caliper (Blade)

For measuring length or diameter of tight spaces.

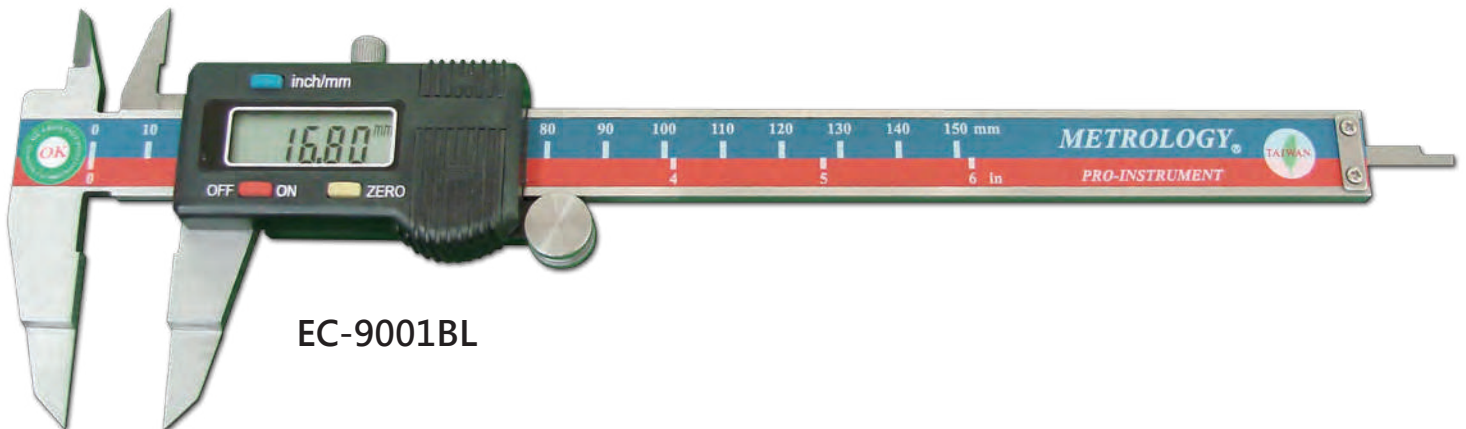

EC-9001BL

Model No.	Measuring Range	Resolution	Accuracy
EC-9001BL	0-150mm/6"	0.01mm/0.0005"	±0.04mm
EC-9002BL	0-200mm/8"		±0.04mm
EC-9003BL	0-300mm/12"		±0.05mm



Remark: the standard measuring jaw thickness is 0.75 mm/ can be special order down to 0.4mm

■ Digital Caliper (Center Distance)

Main scale and the sliding scale measuring jaws are interchangeable.
For measuring center distance between two holes, and hole center to reference face.

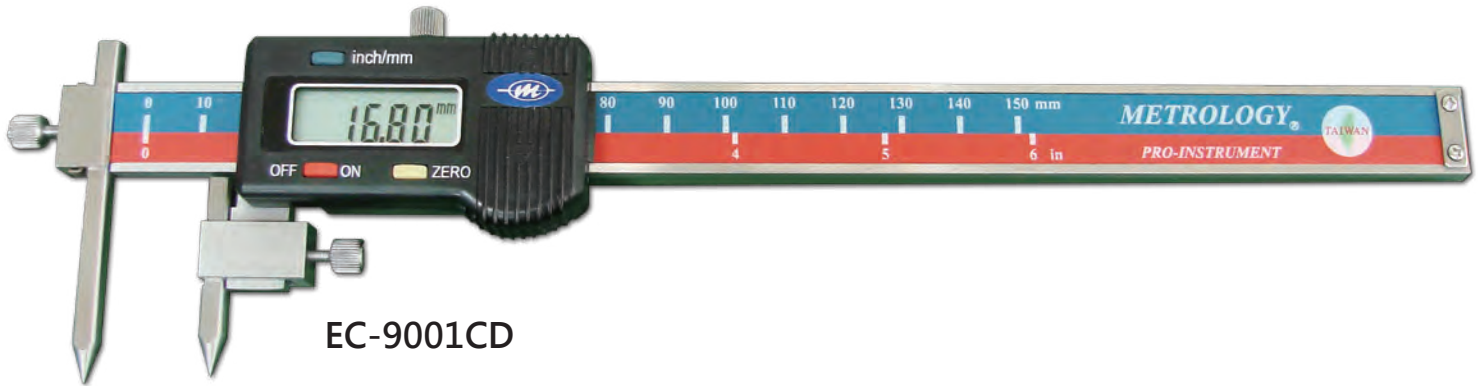

EC-9001CD

Model No.	Measuring Range	Resolution	Accuracy
EC-9001CD	5-150mm/6"	0.01mm/0.0005"	±0.05mm
EC-9002CD	5-200mm/8"		±0.07mm
EC-9003CD	5-300mm/12"		±0.09mm
EC-9004CD	5-500mm/20"		±0.09mm
EC-9005CD	10-1000mm/40"		±0.13mm

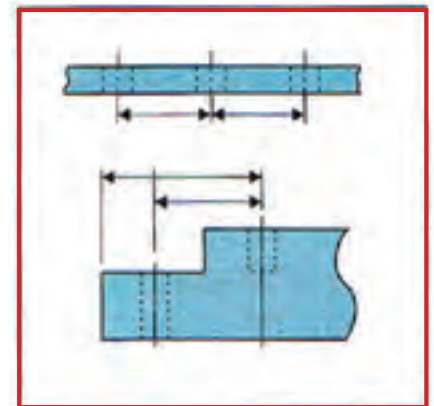

■ Optional Measuring Tip

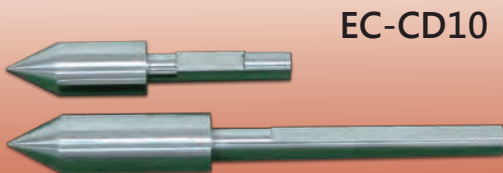

EC-CD10

EC-CD15

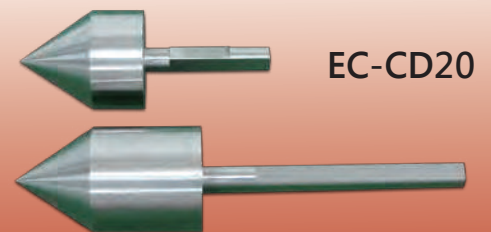

EC-CD20

- Maximum hole diameter : 10 mm (2 piece/pair)
- Maximum hole diameter : 15mm (2 piece/pair)
- Maximum hole diameter : 20mm (2 piece/pair)

Remark: Standard measuring rod diameter is 5mm, Custom rod specs and style can be special ordered.

■ Digital Caliper (Screw)

With interchangeable measuring jaws
For measuring head thickness of screws and length of threads.

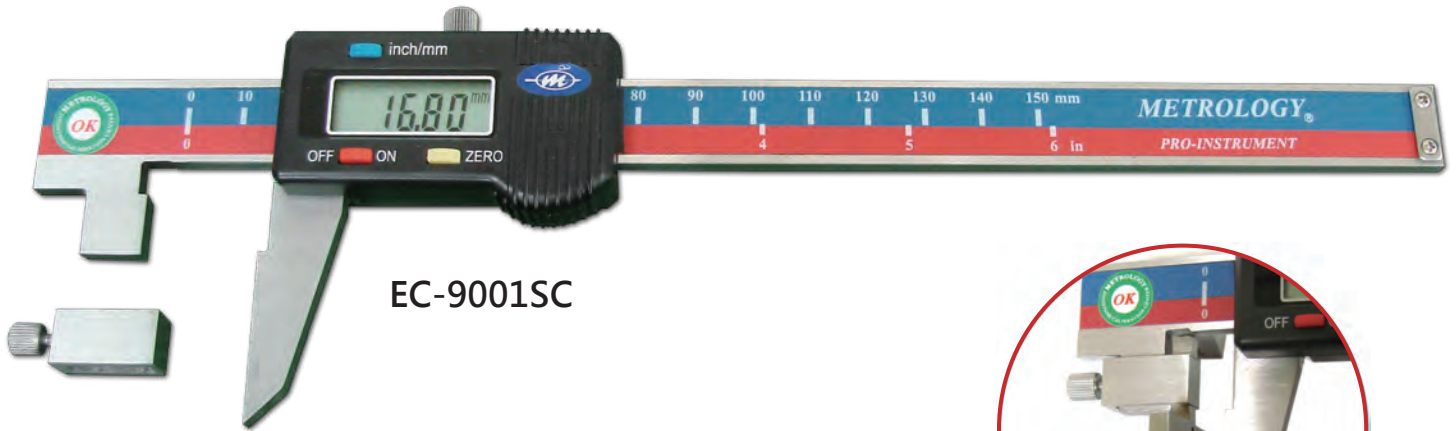

EC-9001SC



Head thickness



Thread length

Model No.	Measuring Range	Resolution	Accuracy
EC-9001SC	0-150mm/6"	0.01mm/0.0005"	±0.04mm
EC-9002SC	0-200mm/8"		±0.04mm
EC-9003SC	0-300mm/12"		±0.05mm

Remark: Standard accessory exclude measuring jaws

■ Optional measuring jaws

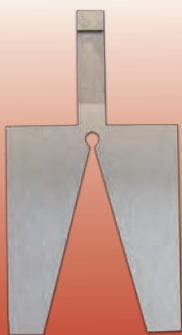

Diameter: for Φ 1-10mm
Size tolerance: ± 0.003 mm
Material: hardened alloy steel
Model Number: EC-SC1

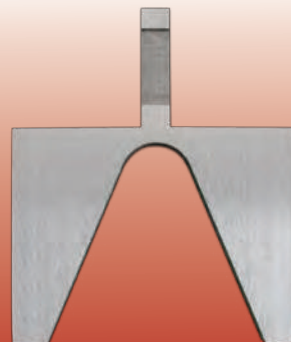

Diameter: for Φ 10-20mm
Size tolerance: ± 0.003 mm
Material: hardened alloy steel
Model Number: EC-SC2

Remark: Standard measuring jaw thickness: 4mm

■ Digital Caliper (Outside Arc Radius)

For measuring external arc radius and diameter of semi-spherical and spherical workpiece.



EC-9001OR

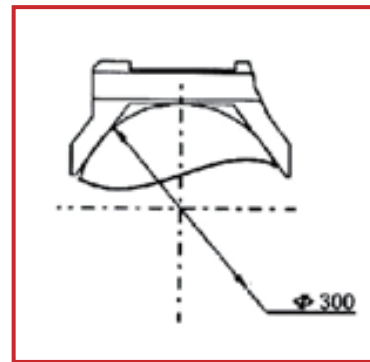

Model No.	Measuring Range	Resolution	Accuracy
EC-9001OR	R3-150mm/6"	0.01mm/0.0005"	±0.06mm
EC-9002OR	R3-200mm/8"		±0.1mm

■ Digital Caliper (Disc)

For measuring thickness of sheets, paper, aluminum, plastic, metal, and gear teeth.

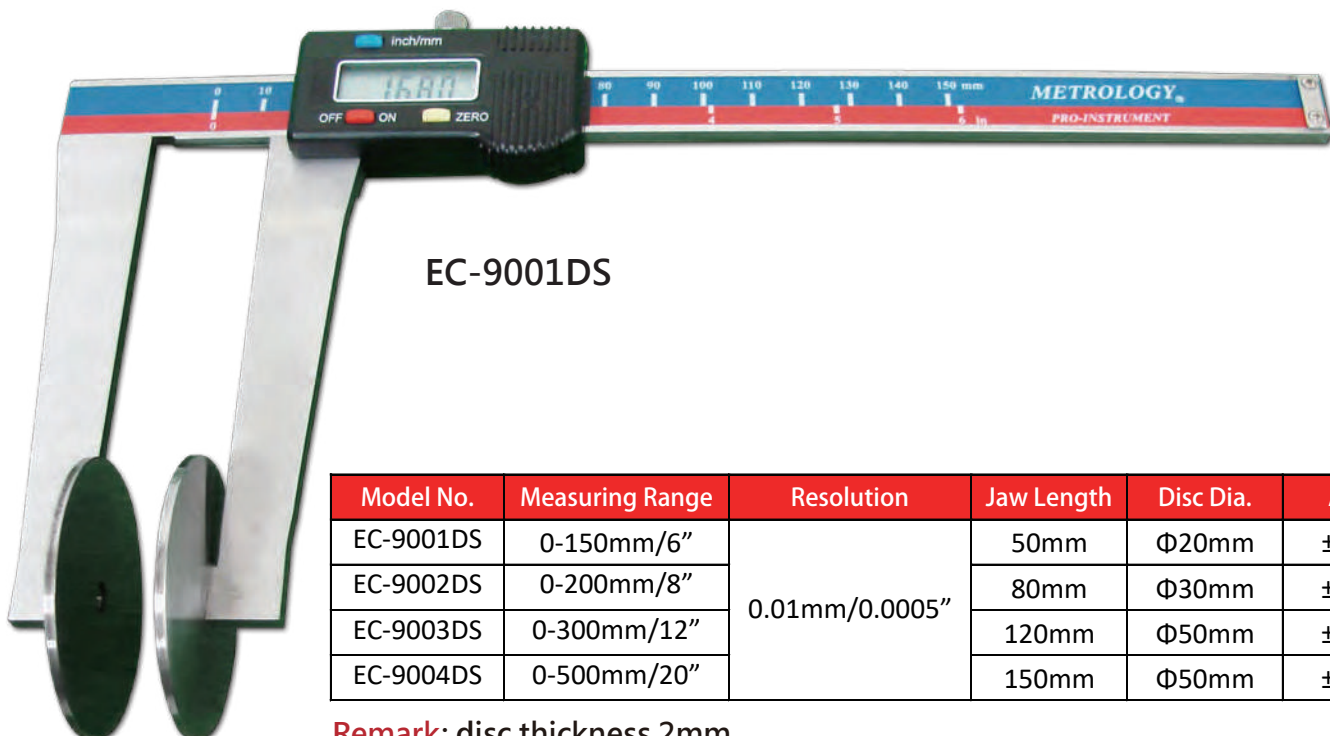

EC-9001DS

Model No.	Measuring Range	Resolution	Jaw Length	Disc Dia.	Accuracy
EC-9001DS	0-150mm/6"	0.01mm/0.0005"	50mm	Φ20mm	±0.04mm
EC-9002DS	0-200mm/8"		80mm	Φ30mm	±0.05mm
EC-9003DS	0-300mm/12"		120mm	Φ50mm	±0.06mm
EC-9004DS	0-500mm/20"		150mm	Φ50mm	±0.07mm

Remark: disc thickness 2mm

■ Digital Caliper (Groove Width)

For measuring width, distance of internal grooves and distance from groove to reference face.

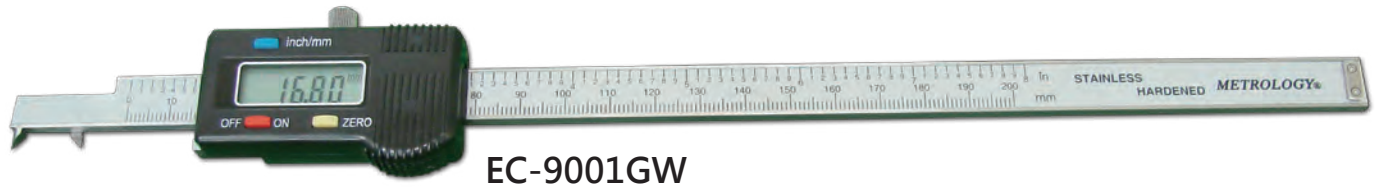

EC-9001GW

Model No.	Measuring Range	Resolution	Accuracy
EC-9001GW	3-150mm/6"	0.01mm/0.0005"	±0.03mm
EC-9002GW	3-200mm/8"		±0.03mm
EC-9003GW	4-300mm/12"		±0.04mm

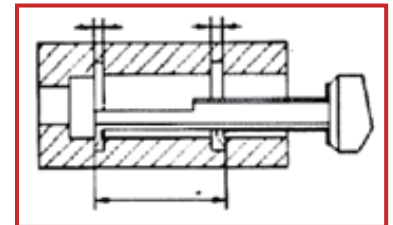

Remark: Main beam width : 17 mm, measuring jaw total width 13xL23mm, jaw width 3mm, and depth 4mm

■ Caliper (Gear Tooth)

For measures gear tooth thickness on the primary diameter.

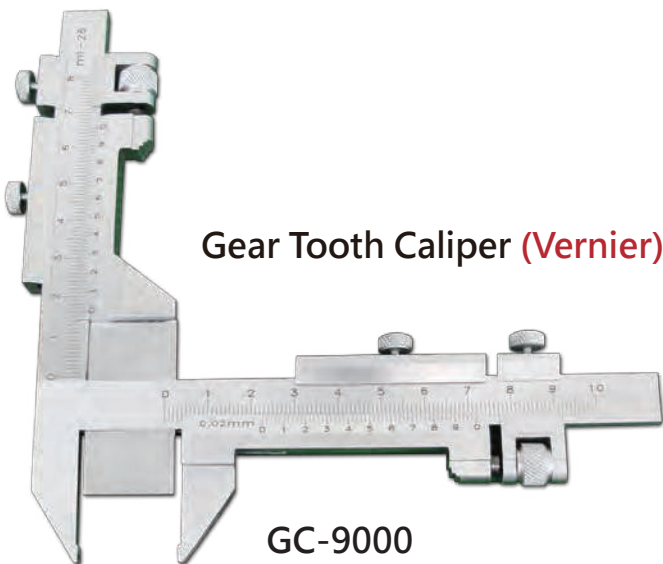

Gear Tooth Caliper (Vernier)

GC-9000

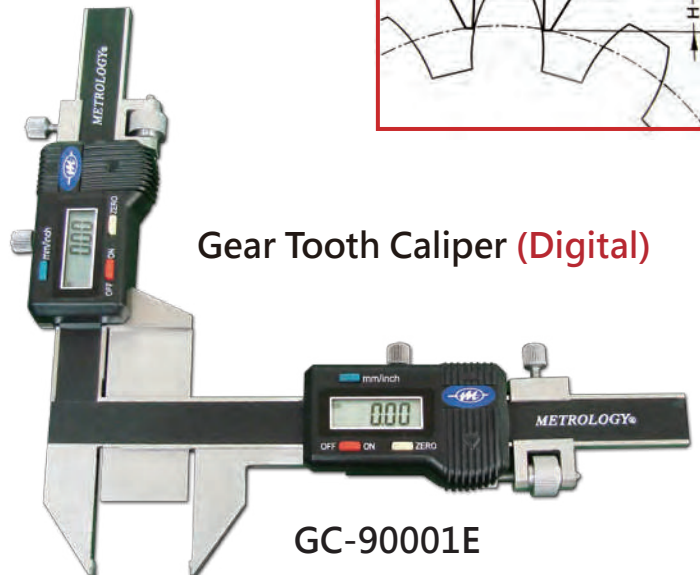

Gear Tooth Caliper (Digital)

GC-90001E

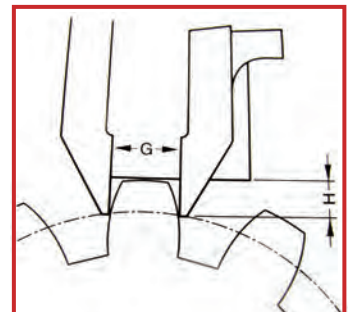

Model No.	Measuring Range	Graduation	Accuracy
GC-9000	M1-26	0.02mm	±0.03mm

Model No.	Measuring Range	Resolution	Accuracy
GC-9001E	M1-25	0.01mm/0.0005"	±0.04mm
GC-9002E	M5-50		

■ Digital Caliper (Mini)



Model No.	Measuring Range	Resolution	Accuracy (MPE)
EC-9100S	0-100mm / 4"	0.01mm/0.0005"	0.03mm/0.0015"

■ Vernier Caliper (Parallel Scribing)

For workpiece dimension scribing and measuring tube thickness.



Model No.	Measuring Range	Graduation	Accuracy
VC-9200S	0-200mm/8"	0.1mm/1/128"	±0.1mm

Remark: with Ø 2mm interchangeable tungsten scribing pin

■ Caliper Depth Base

Suitable for calipers within the range of 0 to 300mm. For support of measuring depths.

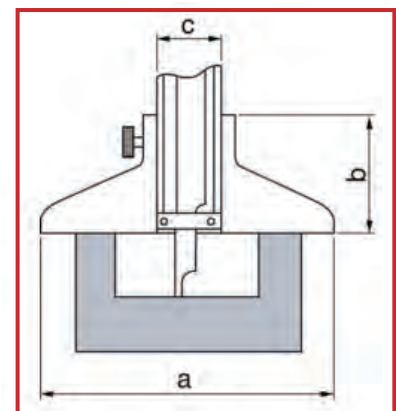
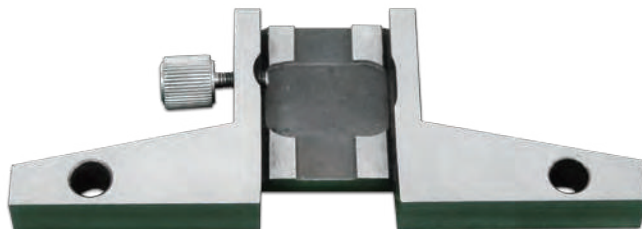

Model No.	Measuring Face	Scale Width	Range
CD-BASE1	80*7.5mm	16mm	For 0-200mm
CD-BASE2	80*7.5mm	17mm	For 0-300mm

Material: Stainless Steel